

DECO AREA

CAP

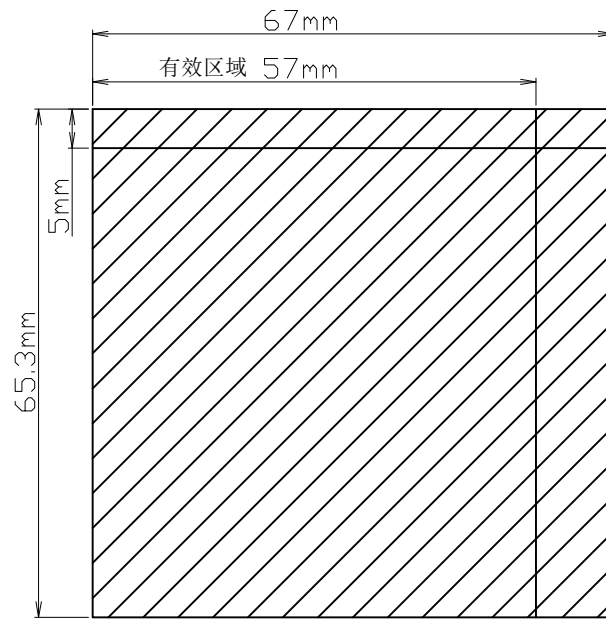

CAP

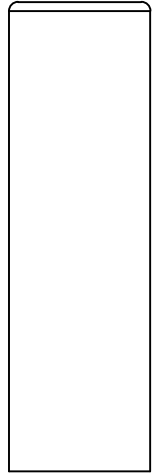
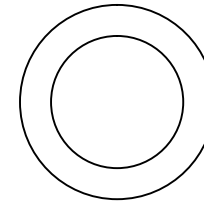

$\phi 16.95\text{mm}$

$\phi 24.95\text{mm}$

BODY

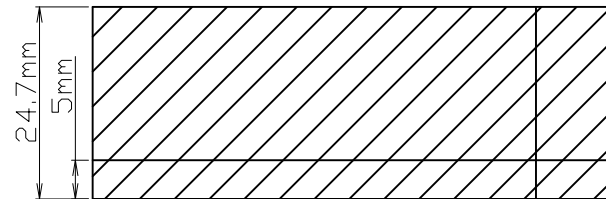
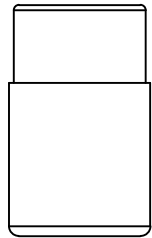

BODY

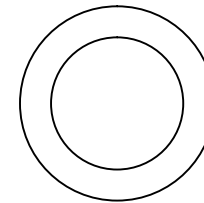

$\phi 16.95\text{mm}$

$\phi 24.95\text{mm}$

No.	NAME	Material
1	CAP	PAPER
2	BODY	PAPER
3	MECHANISM	---

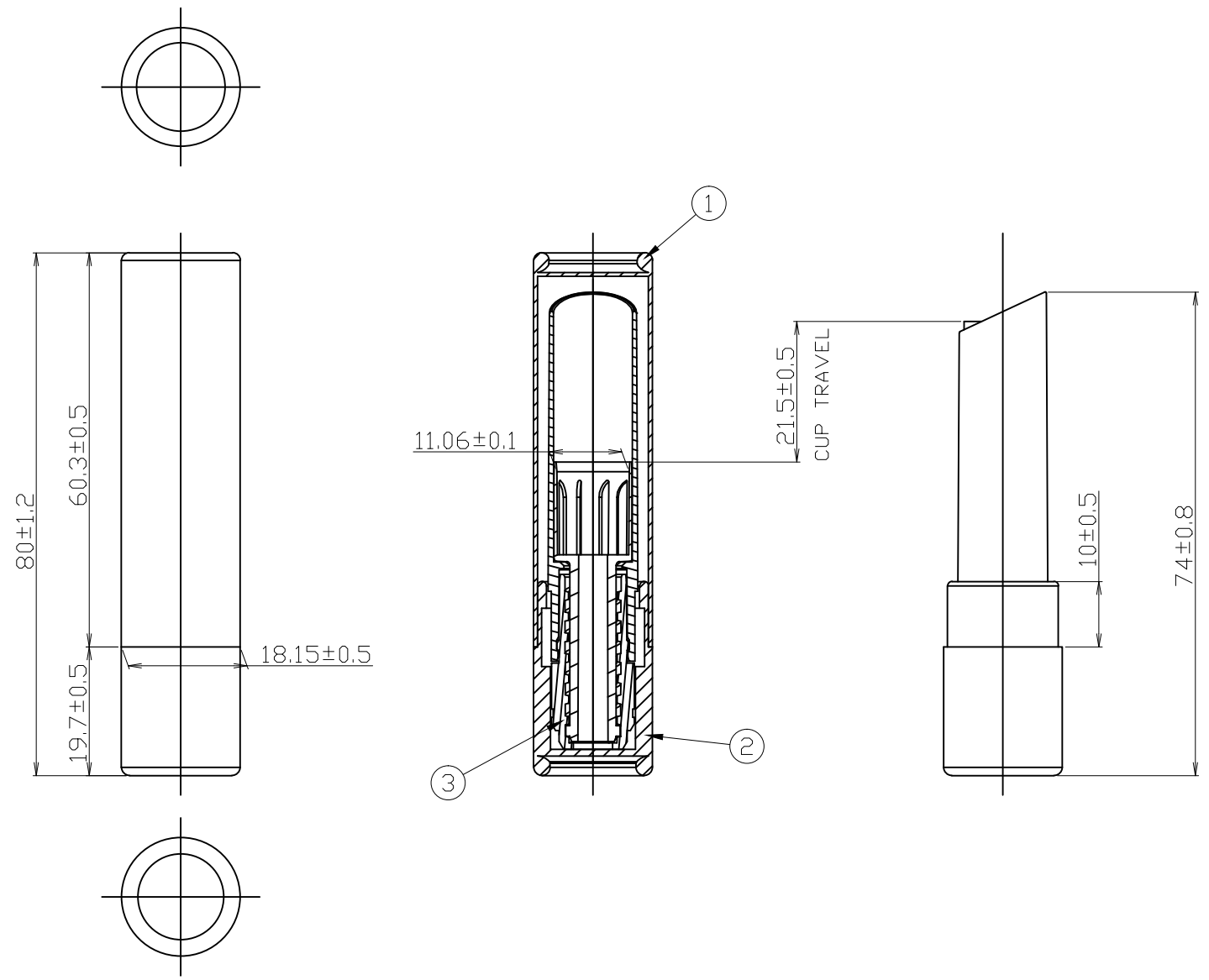

PL2020003-paper